

Low Cost, Low Noise $\pm 2 g$ Dual Axis Accelerometer with Digital Outputs

MXD7202G/H/M/N

FEATURES

- Low cost
- Resolution better than 1 milli-g
- Dual axis accelerometer fabricated on a monolithic CMOS IC
- On chip mixed signal processing
- No moving parts; No loose particle issues
- >50,000 g shock survival rating
- 5mm X 5mm X 2mm LCC package
- 2.7V to 5.25V single supply continuous operation
- Compensated for Sensitivity over temperature
- Ultra low initial Zero-g Offset
- No adjustment needed outside

APPLICATIONS

- Security – Gas Line/Elevator/Fatigue Sensing
- Information Appliances – Computer Peripherals/PDA's/Mouse Smart Pens/Cell Phones
- Gaming – Joystick/RF Interface/Menu Selection/Tilt Sensing
- GPS – electronic Compass tilt Correction
- Consumer – LCD projectors, pedometers, blood pressure Monitor, digital cameras

GENERAL DESCRIPTION

The MXD7202G/H/M/N is a low cost, dual axis accelerometer fabricated on a standard, submicron CMOS process. It is a complete sensing system with on-chip mixed signal processing. The MXD7202G/H/M/N measures acceleration with a full-scale range of $\pm 2 g$ and a sensitivity of 12.5%/g @5V at 25°C. It can measure both dynamic acceleration (e.g. vibration) and static acceleration (e.g. gravity). The MXD7202G/H/M/N design is based on heat convection and requires no solid proof mass. This eliminates stiction and particle problems associated with competitive devices and provides shock survival greater than 50,000 g, leading to significantly lower failure rate and lower loss due to handling during assembly and at customer field application.

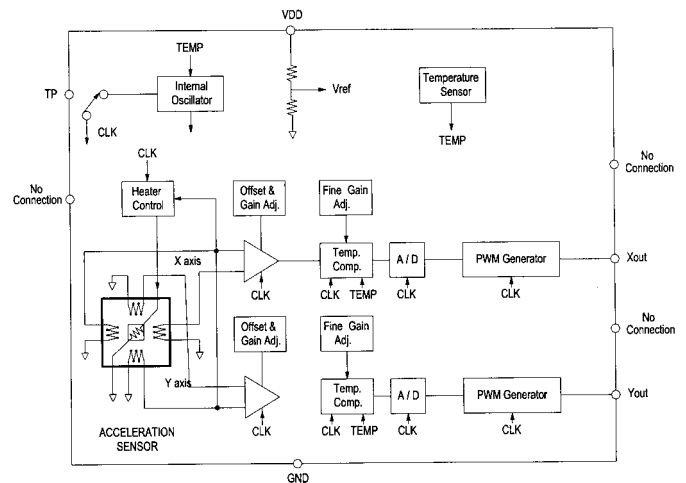

MXD7202G/H/M/N FUNCTIONAL BLOCK DIAGRAM

The MXD7202G/H/M/N provides two digital outputs that are set to 50% duty cycle at zero g acceleration. The outputs are digital with duty cycles (ratio of pulse width to period) that are proportional to acceleration. The duty cycle outputs can be directly interfaced to a microprocessor.

The typical noise floor is $0.3 \text{ mg}/\sqrt{\text{Hz}}$ allowing signals below 1 milli-g to be resolved at 1 Hz bandwidth. The MXD7202G/H/M/N is packaged in a hermetically sealed LCC surface mount package (5 mm x 5 mm x 2 mm height) and is operational over a 0°C to 70°C(G/H) or a -40°C to +105°C(M/N) temperature range.

Information furnished by MEMSIC is believed to be accurate and reliable. However, no responsibility is assumed by MEMSIC for its use, nor for any infringements of patents or other rights of third parties which may result from its use. No license is granted by implication or otherwise under any patent or patent rights of MEMSIC.

©MEMSIC, Inc.
800 Turnpike St., Suite 202, North Andover, MA 01845
Tel: 978.738.0900 Fax: 978.738.0196
www.memsic.com

MXD7202G/H/M/N SPECIFICATIONS (Measurements @ 25°C, Acceleration = 0 g unless otherwise noted; V_{DD} = 5.0V unless otherwise specified)

Parameter	Conditions	MXD7202G/H			MXD7202M/N			Units
		Min	Typ.	Max	Min.	Typ.	Max.	
SENSOR INPUT								
Measurement Range ¹	Each Axis	±2.0			±2.0			g
Nonlinearity	Best fit straight line		0.5	1.0		0.5	1.0	% of FS
Alignment Error ²			±1.0			±1.0		degrees
Alignment Error	X Sensor to Y Sensor		0.01			0.01		Degrees
Cross Axis Sensitivity ³			±0.5			±0.5		%
SENSITIVITY								
Duty cycle per g	V _{DD} =5.0V	11.5	12.5	13.5	11.5	12.5	13.5	%/g
Duty cycle per g	V _{DD} =3.0V	11.3	12.5	13.7	11.3	12.5	13.7	%/g
Sensitivity Change over Temperature ⁴	Delta from 25°C			10			15	%
ZERO g BIAS LEVEL								
0 g Duty cycle	V _{DD} =5.0V	47	50	53	47	50	53	%
0 g Duty cycle	V _{DD} =5.0V	-0.24	0.00	0.24	-0.24	0.00	0.24	g
0 g Duty cycle	V _{DD} =3.0V	46	50	54	46	50	54	%
0 g Duty cycle	V _{DD} =3.0V	-0.32	0.00	0.32	-0.32	0.00	0.32	g
0 g Offset vs. Temperature ⁴	Delta from 25°C		1.5			1.5		mg/°C
NOISE PERFORMANCE								
Noise Density, rms	@25°C		0.3	0.8		0.3	0.8	mg/√Hz
FREQUENCY RESPONSE								
3dB Bandwidth		17	19	21	17	19	21	Hz
DUTY CYCLE OUTPUT STAGE								
Output High Voltage		4.8			4.8			V
Output Low Voltage				0.2			0.2	V
Output Frequency	MXD7202G/M	95	100	105	95	100	105	Hz
	MXD7202H/N	380	400	420	380	400	420	Hz
Current	Source or sink @ 2.7V- 5.25V Supply			100			100	uA
Rise/Fall Time			200			200		ns
POWER SUPPLY								
Operating Voltage Range		2.7		5.25	2.7		5.25	V
Quiescent Supply Current	@5.0V		3.0	3.8		3.0	3.8	mA
Quiescent Supply Current	@3.0V		3.4	4.3		3.4	4.3	mA
Turn-On Time ⁵			160			160		mS
TEMPERATURE RANGE								
Operating Range		0		+70	-40		+105	°C

NOTES

¹ Guaranteed by measurement of initial offset and sensitivity.

² Alignment error is specified as the angle between the true and indicated axis of sensitivity.

³ Cross axis sensitivity is the algebraic sum of the alignment and the inherent sensitivity errors.

⁴ Defined as the output change from ambient to maximum temperature or ambient to minimum temperature.

⁵ Output settled to within ±17mg.

ABSOLUTE MAXIMUM RATINGS*

Supply Voltage (V_{DD})-0.5 to +7.0V
 Storage Temperature-65°C to +150°C
 Acceleration50,000 g

*Stresses above those listed under Absolute Maximum Ratings may cause permanent damage to the device. This is a stress rating only; the functional operation of the device at these or any other conditions above those indicated in the operational sections of this specification is not implied. Exposure to absolute maximum rating conditions for extended periods may affect device reliability.

Pin Description: LCC-8 Package

Pin	Name	Description
1	NC	Do Not Connect
2	TP	Connected to ground
3	COM	Common
4	Yout	Y Channel Duty Cycle Output
5	Xout	X Channel Duty Cycle Output
6	NC	Do Not Connect
7	NC	Do Not Connect
8	V _{DD}	2.7V to 5.25V

Ordering Guide

Model	PWM Frequency	Temperature Range	Package
MXD7202GL	100Hz	0 to 70°C	LCC8 RoHS compliant
MXD7202HL	400Hz	0 to 70°C	LCC8 RoHS compliant
MXD7202ML	100Hz	-40 to +105°C	LCC8 RoHS compliant
MXD7202NL	400Hz	-40 to +105°C	LCC8 RoHS compliant
MXD7202GF	100Hz	0 to 70°C	LCC8, Pb-free
MXD7202HF	400Hz	0 to 70°C	LCC8, Pb-free
MXD7202MF	100Hz	-40 to +105°C	LCC8, Pb-free
MXD7202NF	400Hz	-40 to +105°C	LCC8, Pb-free

All parts are shipped in tape and reel packaging.

Caution: ESD (electrostatic discharge) sensitive device.

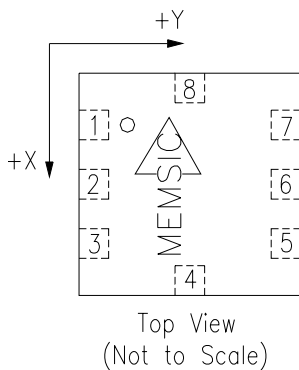

Note: The MEMSIC logo’s arrow indicates the -X sensing direction of the device. The +Y sensing direction is rotated 90° away from the +X direction following the right-hand rule. Small circle indicates pin one(1).



THEORY OF OPERATION

The MEMSIC device is a complete dual-axis acceleration measurement system fabricated on a monolithic CMOS IC process. The device operation is based on heat transfer by natural convection and operates like other accelerometers having a proof mass. The proof mass in the MEMSIC sensor is a gas.

A single heat source, centered in the silicon chip is suspended across a cavity. Equally spaced aluminum/polysilicon thermopiles (groups of thermocouples) are located equidistantly on all four sides of the heat source (dual axis). Under zero acceleration, a temperature gradient is symmetrical about the heat source, so that the temperature is the same at all four thermopiles, causing them to output the same voltage.

Acceleration in any direction will disturb the temperature profile, due to free convection heat transfer, causing it to be asymmetrical. The temperature, and hence voltage output of the four thermopiles will then be different. The differential voltage at the thermopile outputs is directly proportional to the acceleration. There are two identical acceleration signal paths on the accelerometer, one to measure acceleration in the x-axis and one to measure acceleration in the y-axis. Please visit the MEMSIC website at www.memsic.com for a picture/graphic description of the free convection heat transfer principle.

MXD7202G/H/M/N PIN DESCRIPTIONS

V_{DD} – This is the supply input for the circuits and the sensor heater in the accelerometer. The DC voltage should be between 2.7 and 5.25 volts. Refer to the section on PCB layout and fabrication suggestions for guidance on external parts and connections recommended.

COM– This is the ground pin for the accelerometer.

TP– This pin should be connected to ground.

X_{out} – This pin is the digital output of the X-axis acceleration sensor. It is factory programmable to 100Hz or 400Hz. The user should ensure the load impedance is sufficiently high as to not source/sink >100µA typical. While the sensitivity of this axis has been programmed at the factory to be the same as the sensitivity for the y-axis, the accelerometer can be programmed for non-equal sensitivities on the x- and y-axes. Contact the factory for additional information.

Y_{out} – This pin is the digital output of the Y-axis acceleration sensor. It is factory programmable to 100Hz or 400Hz. The user should ensure the load impedance is sufficiently high as to not source/sink >100µA typical. While the sensitivity of this axis has been programmed at the factory to be the same as the sensitivity for the x-axis, the accelerometer can be programmed for non-equal sensitivities on the x- and y-axes. Contact the factory for additional information.

DISCUSSION OF TILT APPLICATIONS AND RESOLUTION

Tilt Applications: One of the most popular applications of the MEMSIC accelerometer product line is in tilt/inclination measurement. An accelerometer uses the force of gravity as an input to determine the inclination angle of an object.

A MEMSIC accelerometer is most sensitive to changes in position, or tilt, when the accelerometer’s sensitive axis is perpendicular to the force of gravity, or parallel to the Earth’s surface. Similarly, when the accelerometer’s axis is parallel to the force of gravity (perpendicular to the Earth’s surface), it is least sensitive to changes in tilt.

Table 1 and Figure 1 help illustrate the output changes in the X- and Y-axes as the unit is tilted from +90° to 0°. Notice that when one axis has a small change in output per degree of tilt (in mg), the second axis has a large change in output per degree of tilt. The complementary nature of these two signals permits low cost accurate tilt sensing to be achieved with the MEMSIC device (reference application note AN-00MX-007).

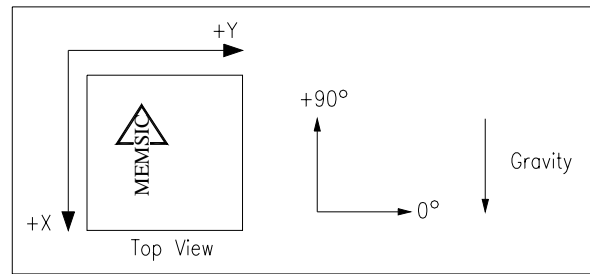

Figure 1: Accelerometer Position Relative to Gravity

X-Axis Orientation To Earth's Surface (deg.)	X-Axis		Y-Axis	
	X Output (g)	Change per deg. of tilt (mg)	Y Output (g)	Change per deg. of tilt (mg)
90	-1.000	0.15	0.000	17.45
85	-0.996	1.37	0.087	17.37
80	-0.985	2.88	0.174	17.16
70	-0.940	5.86	0.342	16.35
60	-0.866	8.59	0.500	15.04
45	-0.707	12.23	0.707	12.23
30	-0.500	15.04	0.866	8.59
20	-0.342	16.35	0.940	5.86
10	-0.174	17.16	0.985	2.88
5	-0.087	17.37	0.996	1.37
0	0.000	17.45	1.000	0.15

Table 1: Changes in Tilt for X- and Y-Axes

Resolution: The accelerometer resolution is limited by noise. The output noise will vary with the measurement bandwidth. With the reduction of the bandwidth, by applying an external low pass filter, the output noise drops. Reduction of bandwidth will improve the signal to noise ratio and the resolution. The output noise scales directly with the square root of the measurement bandwidth. The maximum amplitude of the noise, its peak-to-peak value, approximately defines the worst case resolution of the measurement. With a simple RC low pass filter, the rms noise is calculated as follows:

$$\text{Noise (mg rms)} = \text{Noise(mg}/\sqrt{\text{Hz}}) * \sqrt{(\text{Bandwidth(Hz)} * 1.6)}$$

The peak-to-peak noise is approximately equal to 6.6 times the rms value (for an average uncertainty of 0.1%).

DIGITAL INTERFACE

The MXD7202G/H/M/N is easily interfaced with low cost microcontrollers. For the digital output accelerometer, one digital input port is required to read one accelerometer output. For the analog output accelerometer, many low cost microcontrollers are available today that feature integrated A/D (analog to digital converters) with resolutions ranging from 8 to 12 bits.

In many applications the microcontroller provides an effective approach for the temperature compensation of the

sensitivity and the zero g offset. Specific code set, reference designs, and applications notes are available from the factory. The following parameters must be considered in a digital interface:

- Resolution:** smallest detectable change in input acceleration
- Bandwidth:** detectable accelerations in a given period of time
- Acquisition Time:** the duration of the measurement of the acceleration signal

DUTY CYCLE DEFINITION

The MXD7202G/H/M/N has two PWM duty cycle outputs (x,y). The acceleration is proportional to the ratio T1/T2. The zero g output is set to 50% duty cycle and the sensitivity scale factor is set to 12.5% duty cycle change per g. These nominal values are affected by the initial tolerance of the device including zero g offset error and sensitivity error. This device is offered from the factory programmed to either a 10ms period (100 Hz) or a 2.5ms period (400Hz).

- T1** Length of the “on” portion of the cycle.
- T2 (Period)** Length of the total cycle.
- Duty Cycle** Ratio of the “On” time (T1) of the cycle to the total cycle (T2). Defined as T1/T2.
- Pulse width** Time period of the “on” pulse. Defined as T1.

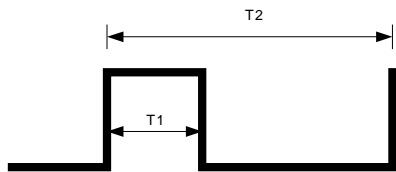

$A (g) = (T1/T2 - 0.5) / 0.125$
0g = 50% Duty Cycle
T2 = 2.5ms or 10ms (factory programmable)

Figure 2: Typical output Duty Cycle

CHOOSING T2 AND COUNTER FREQUENCY DESIGN TRADE-OFFS

The noise level is one determinant of accelerometer resolution. The second relates to the measurement resolution of the counter when decoding the duty cycle output. The actual resolution of the acceleration signal is limited by the time resolution of the counting devices used to decode the duty cycle. The faster the counter clock, the higher the resolution of the duty cycle and the shorter the T2 period can be for a given resolution. Table 2 shows some of the trade-offs. It is important to note that this is the resolution due to the microprocessors’ counter. It is probable that the accelerometer’s noise floor may set the lower limit on the resolution.

T2 (ms)	MEMSIC Sample Rate	Counter-Clock Rate (MHz)	Counts Per T2 Cycle	Counts per g	Resolution (mg)
2.5	400	2.0	5000	625	1.6
2.5	400	1.0	2500	313	3.2
2.5	400	0.5	1250	156	6.4
10.0	100	2.0	20000	2500	0.4
10.0	100	1.0	10000	1250	0.8
10.0	100	0.5	5000	625	1.6

Table 2: Trade-Offs Between Microcontroller Counter Rate and T2 Period.

CONVERTING THE DIGITAL OUTPUT TO AN ANALOG OUTPUT

The PWM output can be easily converted into an analog output by integration. A simple RC filter can do the conversion. Note that the impedance of the circuit following the integrator must be much higher than the impedance of the RC filter. Reference figure 3 for an example.

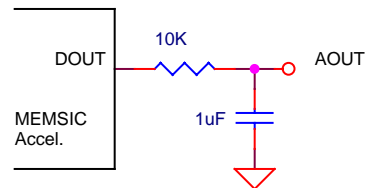

Figure 3: Converting the digital output to an analog voltage

POWER SUPPLY NOISE REJECTION

One capacitor is recommended for best rejection of power supply noise (reference Figure 4 below). The capacitor should be located as close as possible to the device supply pin (VDD). The capacitor lead length should be as short as possible, and surface mount capacitor is preferred. For typical applications, the capacitor can be ceramic 0.1 μF.

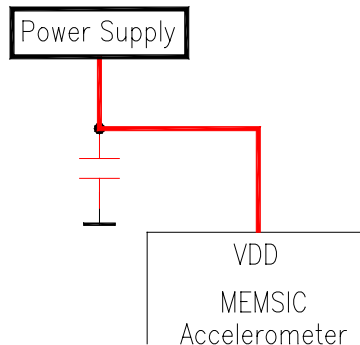

Figure 4: Power Supply Noise Rejection

PCB LAYOUT AND FABRICATION SUGGESTIONS

1. Liberal use of ceramic bypass capacitors is recommended. It is best to connect a 0.1uF capacitor directly across V_{DD} and COM pin.
2. Robust low inductance ground wiring should be used.
3. Care should be taken to ensure there is “thermal symmetry” on the PCB immediately surrounding the
- MEMSIC device and that there is no significant heat source nearby.
4. A metal ground plane should be added directly beneath the MEMSIC device. The size of the plane should be similar to the MEMSIC device’s footprint and be as thick as possible.
5. Vias can be added symmetrically around the ground plane. Vias increase thermal isolation of the device from the rest of the PCB.

MXD7202GL/HL/ML/NL TYPICAL PERFORMANCE CHARACTERISTICS (@ 25°C, unless otherwise specified)

V_{DD} = 3V

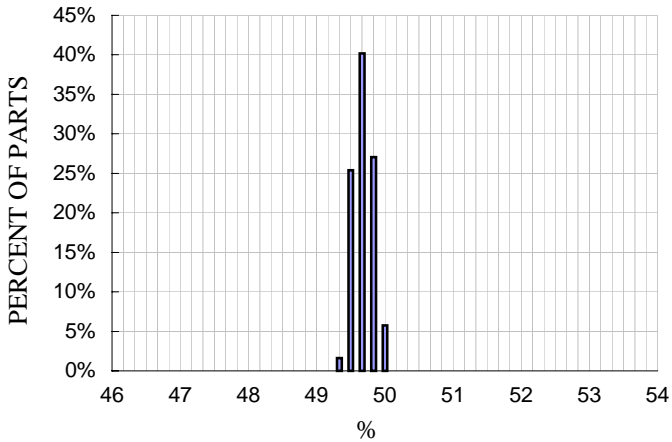

X-axis Zero g Bias Distribution at Xout, V_{DD}=3V

V_{DD} = 5V

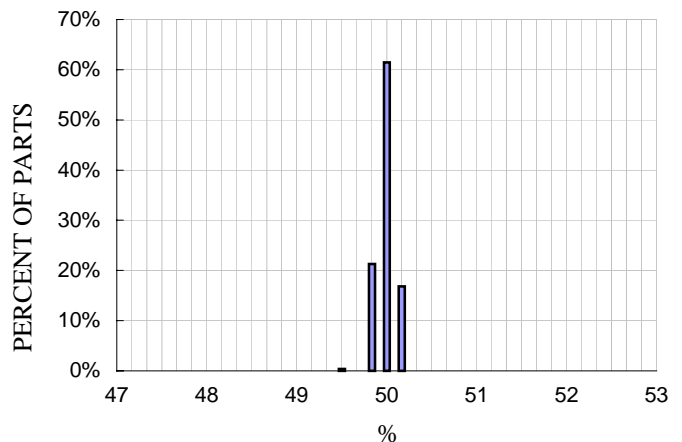

X-axis Zero g Bias Distribution at Xout, V_{DD}=5V

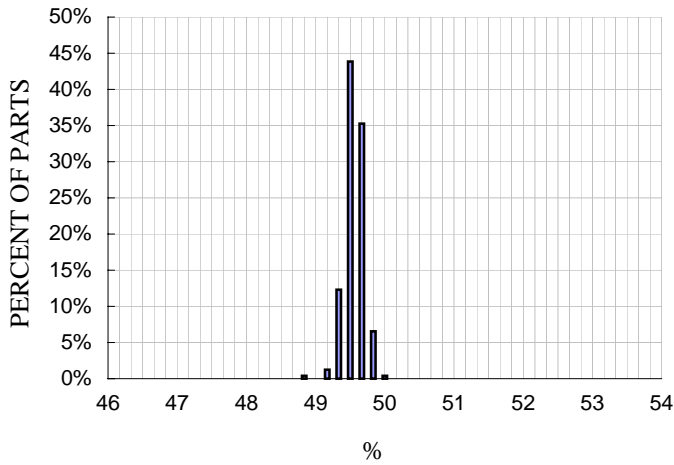

Y-axis Zero g Bias Distribution at Xout, V_{DD}=3V

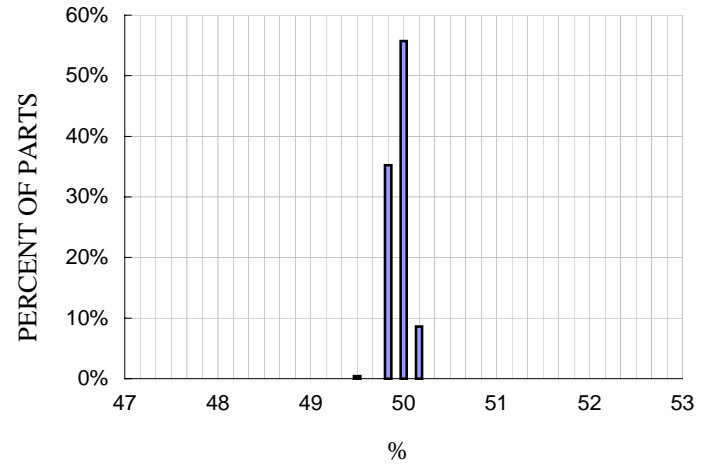

Y-axis Zero g Bias Distribution at Xout, V_{DD}=5V

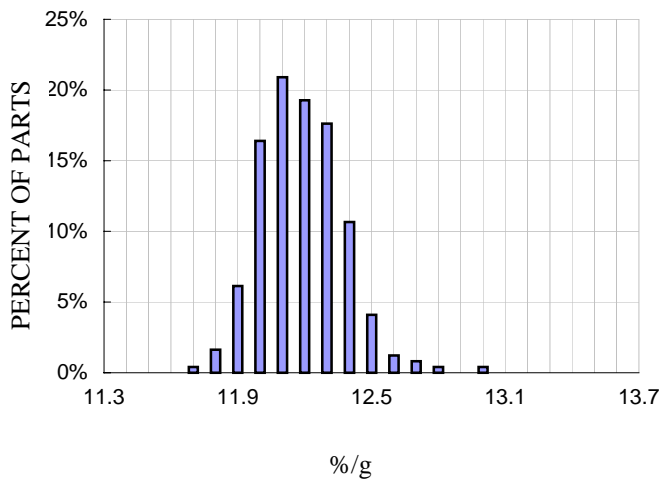

X-axis Sensitivity Distribution at Xout, V_{DD}=3V

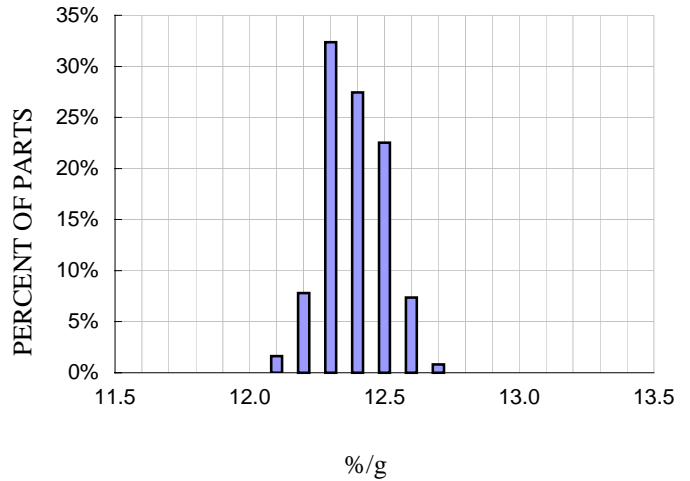

X-axis Sensitivity Distribution at Xout, V_{DD}=5V

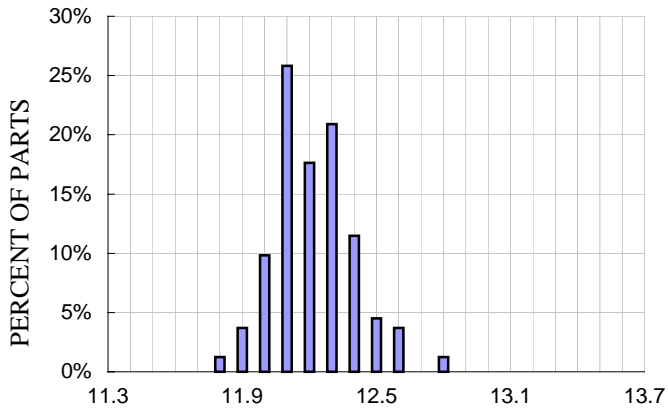

Y-axis Sensitivity Distribution at Yout, $V_{DD}=3V$

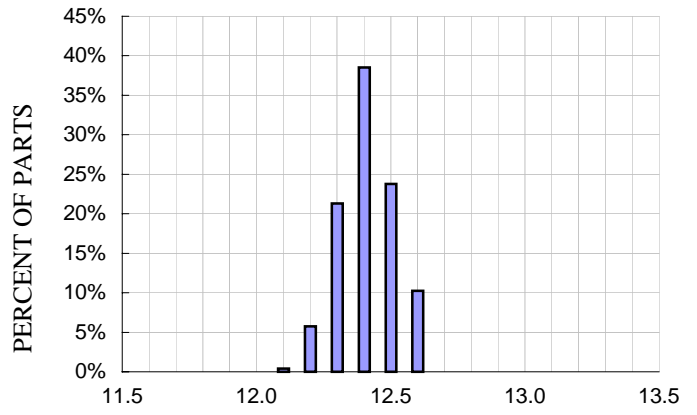

Y-axis Sensitivity Distribution at Yout, $V_{DD}=5V$

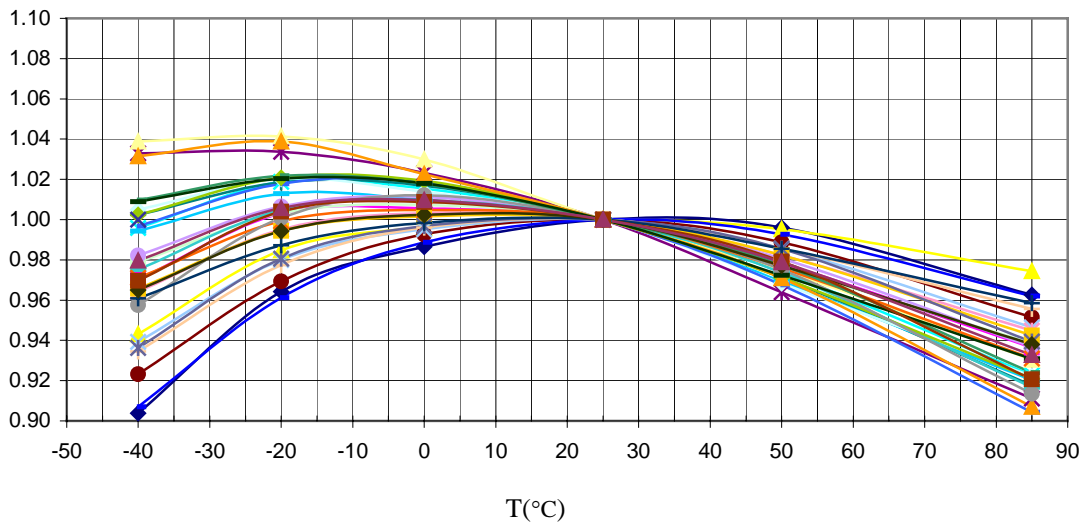

Normalized (with 25°C) X-axis Sensitivity vs. Temperature, $V_{DD}=5V$

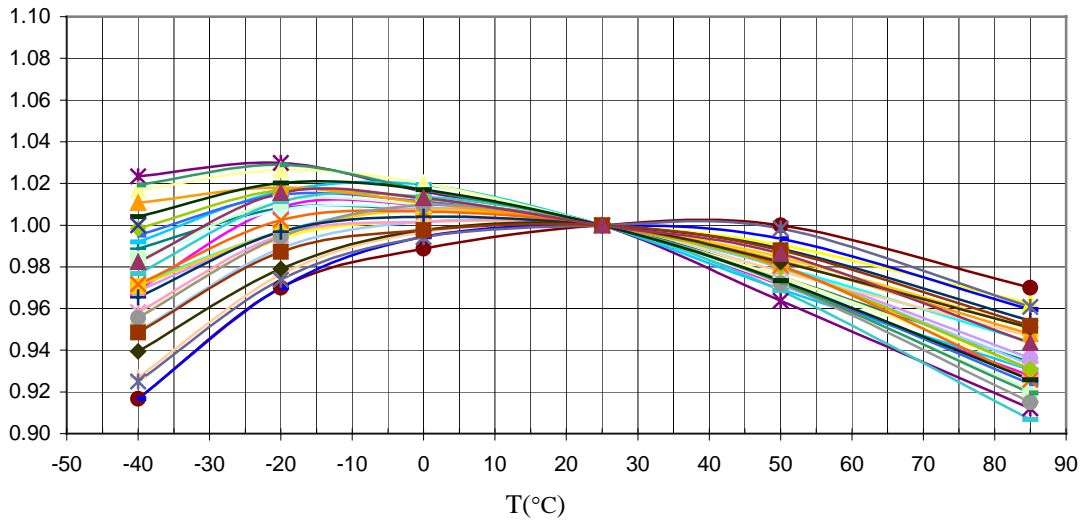

Normalized (with 25°C) Y-axis Sensitivity vs. Temperature, $V_{DD}=5V$

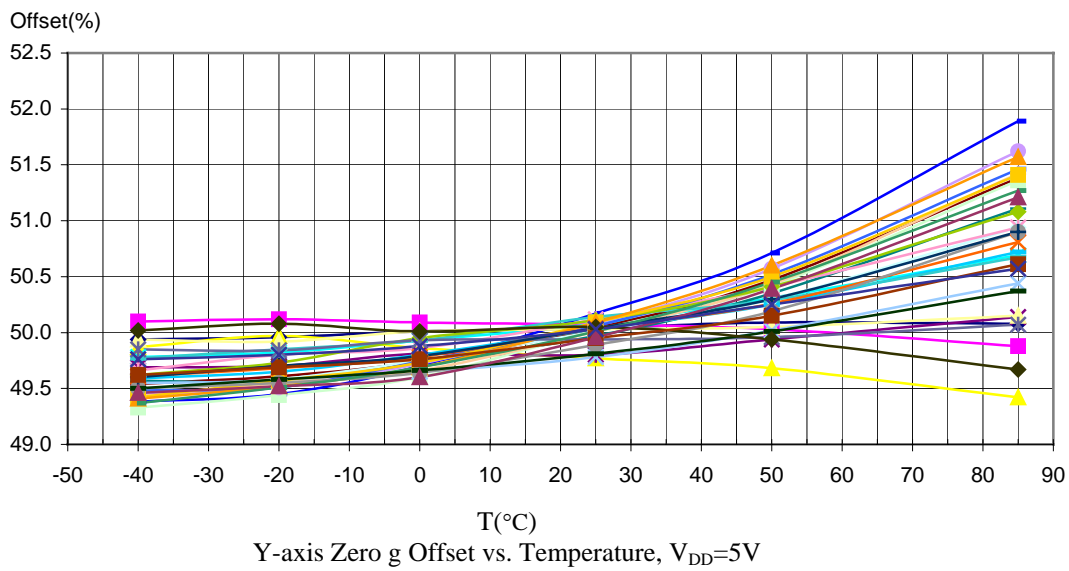
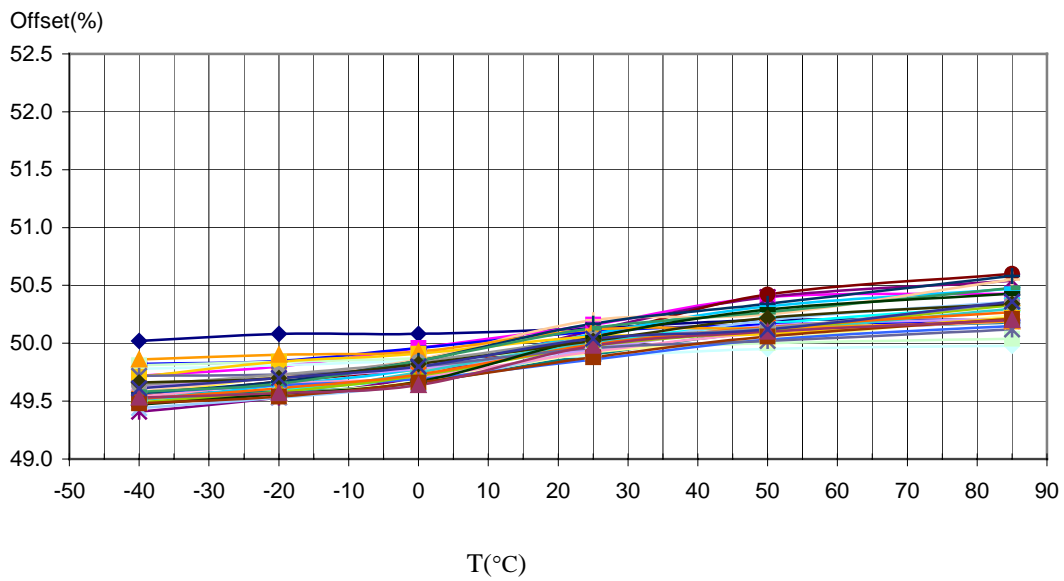

LCC-8 PACKAGE DRAWING

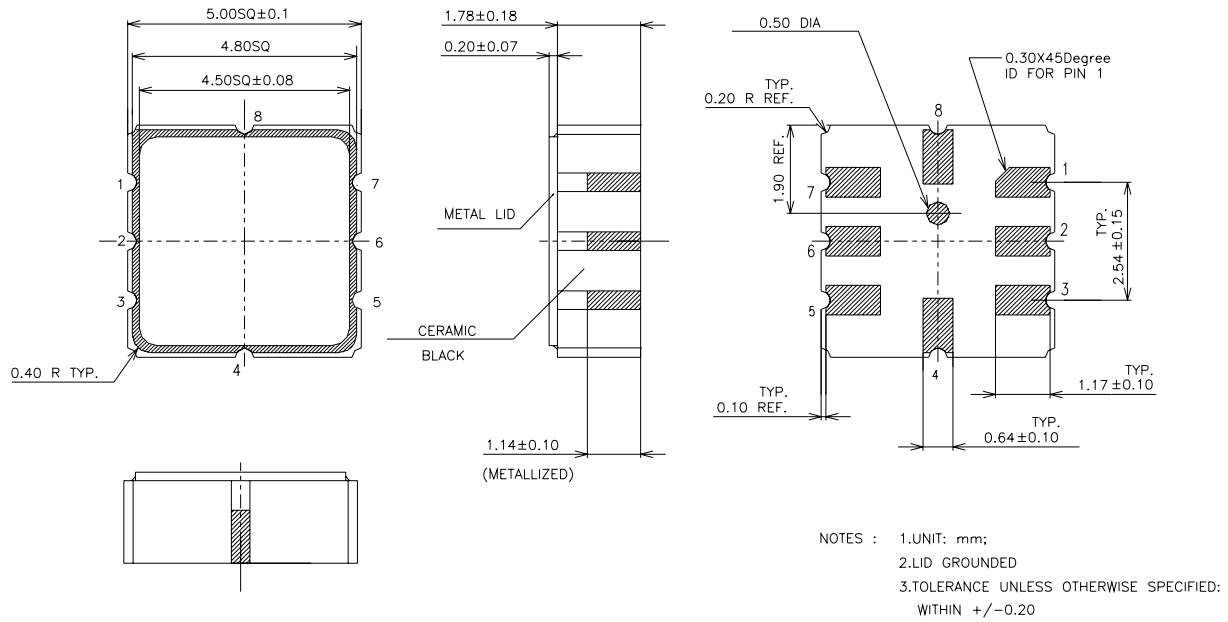

Fig 5: Hermetically Sealed Package Outline